

APPLICATION

- To control the fresh air dampers which are positioned according to trapeze diagram for summer- and winter-operations. Alternatively to regulate the mixed air temp. (e.g. winter-operation) and control of the damper position (e.g. summer-operation).

INSTALLATION

- Suitable for panel, cabinet (rail fixing EN 50024, type C) and wall mounting. The ambient temp. should not fall below 0 °C or rise above 55 °C.
- The bracket provided is essential for panel mounting (see fig. 1).
- When mounting, the fixing bracket must be folded outwards and the complete insert must be pulled out. The fixing holes for 6 mm ϕ screws are located in the base of the case.

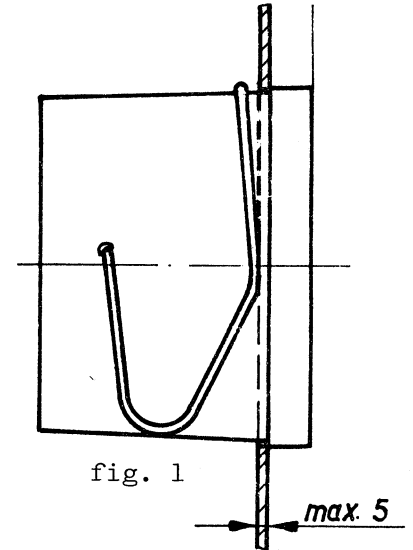

INSTALLATION OF THE INDICATING GAUGES

- Top cut-out : Gauge for connection p5
- Middle cut-out : Gauge for connection p3
- Bottom cut-out : Gauge for output pressure p2
- Remove blanking plate carefully until the pipe, fixed on the rear, can be removed. Reconnect the pipe into the gauge and press the whole unit into the corresponding cut-out.
- Push the tubes from the nipple, don't pull. To avoid broken nipples apply the device for removing of the tubes (service set 297508).
- Shorten the tubes by 3...4 mm if the tube ends are stretched.

OPERATION

- Each instrument has 2 P-controllers. With control action A for input 3 and with control action B for input 5. Because the output pressure of the first controller is the inlet pressure of the second controller, both characteristic lines are shown separately on the outlets.
- By adjusting KP3 and KP5 the cut-off point by 0 bar of the output pressure can be set.
- By adjusting Xp3 and Xp5 determines the gradient of the characteristics A and B.
- Setting facility B limits the output pressure to an adjustable minimum value. An alteration of the limits has no effect on the characteristics A and B.

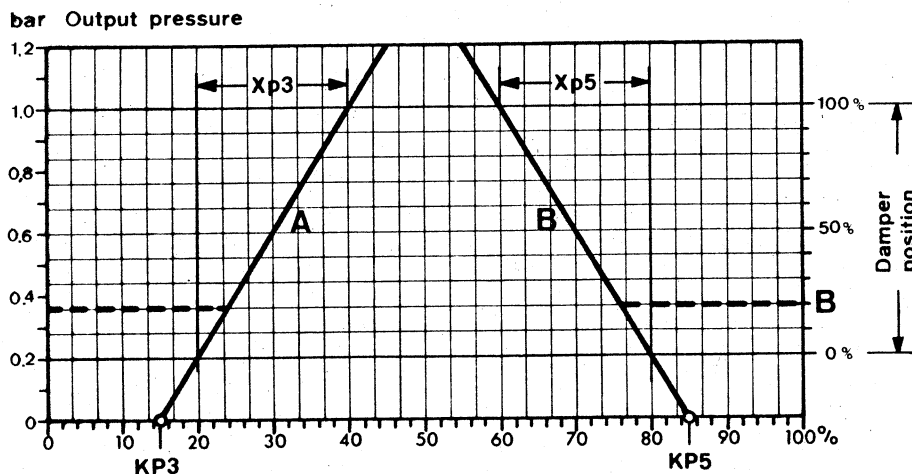

SETTING AS TO GIVEN CHARACTERISTICS

- 1) Draw the desired characteristic on page 3 on an empty graph field.
- 2) The characteristics for control action A and B are extended to the temperature axis (output pressure = 0 bar)
- 3) The cutting points at 0 bar are taken to the % axis and they show the setting values of KP3 and KP5.
- 4) The cutting points at 0,2 bar and 1,0 bar are also taken to the % axis. The differences give the setting values of Xp3 and Xp5 (use scale).
- 5) The limiting value is set directly in % to the damper position.

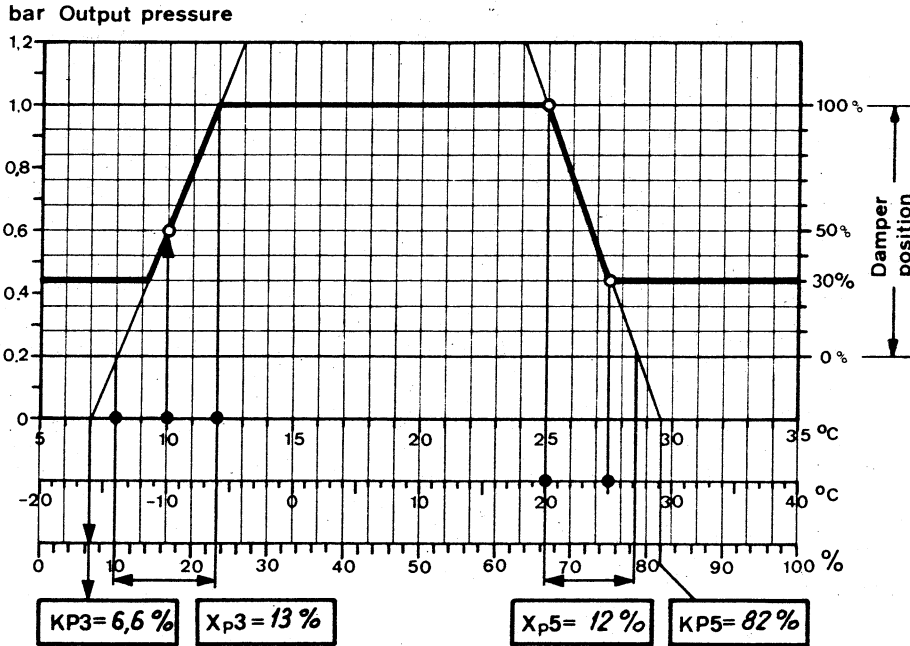

Example:

Fixed value regulation of the mixed air temperature for winter operation, control of the FA-, EA- and RA-damper position in summer operation with minimum limiting of the FA-, EA-damper position.

Given:

Mixed temperature sensor 5...35 °C to connection 3, desired value 10 °C
 P-range 4 °C.
 Outside temp. sensor -20...+40 °C to connection 5
 Damper: "OPEN" at 20 °C, 30 % at 25 °C.

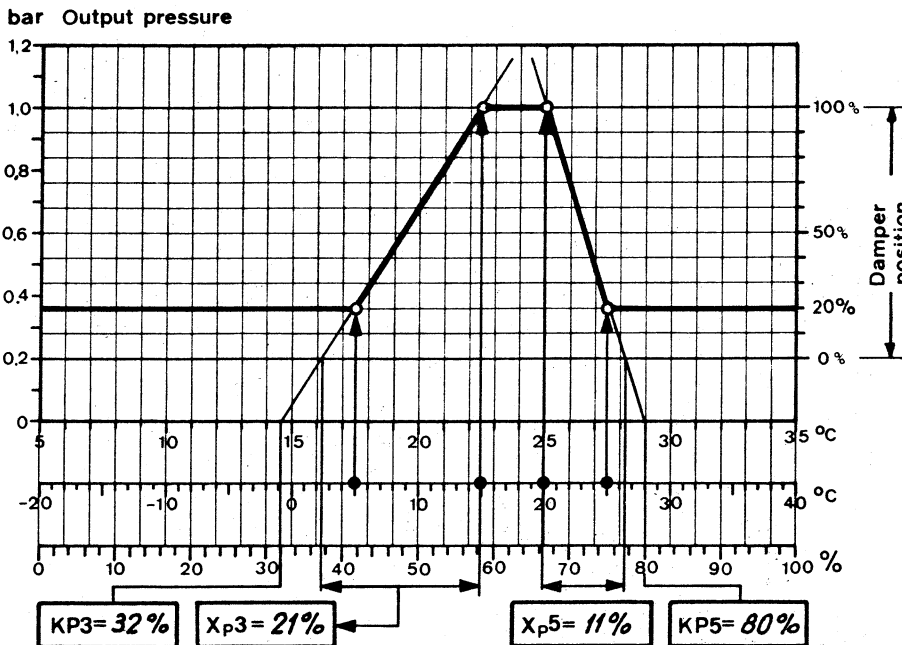

Example:

Control of FA-, EA- and RA-damper position with min. limiting of the FA- and EA-damper position.

Given:

Outside sensor -20...40 °C to connections 3 and 5.
 FA-, EA-damper to the min. value 20 % at 5 °C (Winter) and 25 °C (Summer).
 FA-, EA-damper to the min. value 20 % at 5 °C (Winter) and 25 °C (Summer).
 FA-, EA-damper open at 15...20 °C.

COMMISSIONING

- We advise that the data of the measuring transmitter installed be written in the space provided (positioned on the door) for future checking or recalibration as necessary.

KP3 : Measuring range of sensor at connection 3

Xp3 : Measuring span of sensor at connection 3

KP5 : Measuring range of reference sensor connection 5 (e.g. outside sensor)

Xp5 : Measuring span of reference sensor connection 5.

CONNECTION

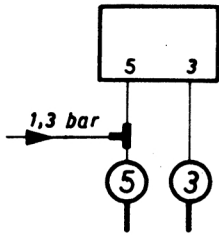

Regulating and controlling with a RCP 40

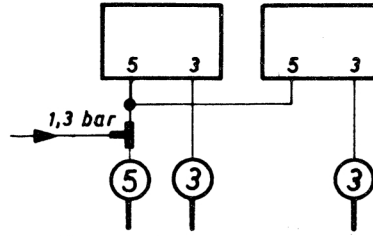

Regulating and controlling with 2...5 RCP 40

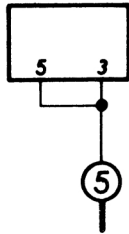

Trapezium diagram with a RCP 40

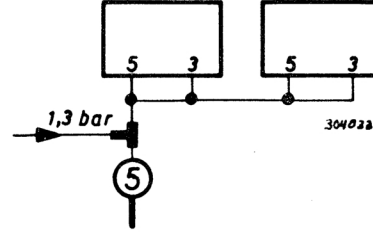

Trapezium diagram with 2...5 RCP 40. The internal restrictor on connection 3 must be blocked on RCP 40 See TI 693.

- All pipes (6 x 1 mm) must be cleaned thoroughly and should be connected with plastic nipples (G 1/8"). The connecting pipes must be completely air tight. For sealing use PTFE strip or sealing stick, (part no. 297169) and not loctite.
- For information regarding the condition of the air supply 1,3 bar ± 0,1, especially at low ambient temperatures, see Installation Instructions MV 01.1.

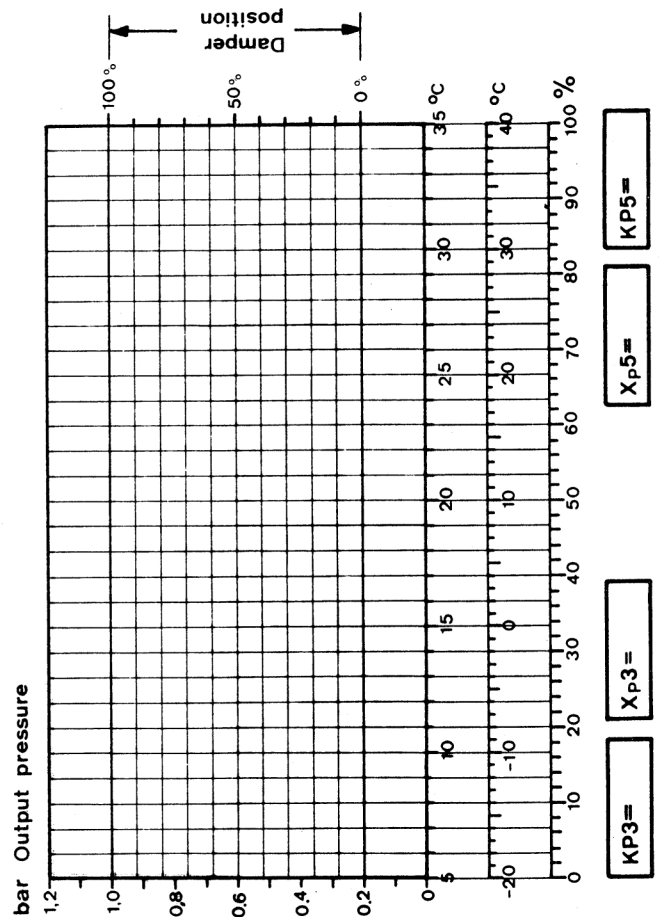
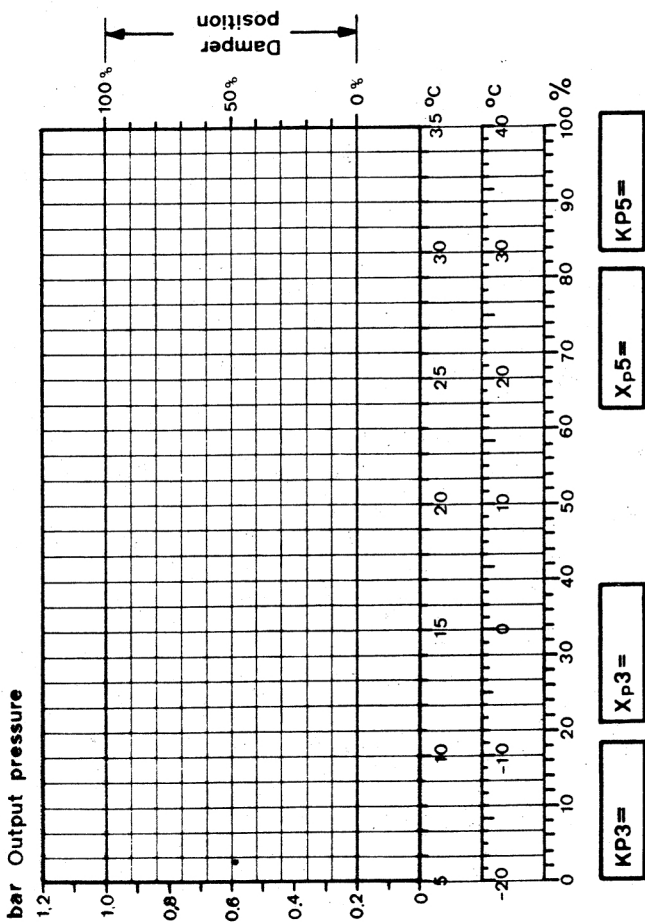

» CENTAIR «

Umrechnung der Messbereiche:
 Conversion des domaines de mesure:
 Conversion of measuring ranges:
 Conversione dei campi di misura:

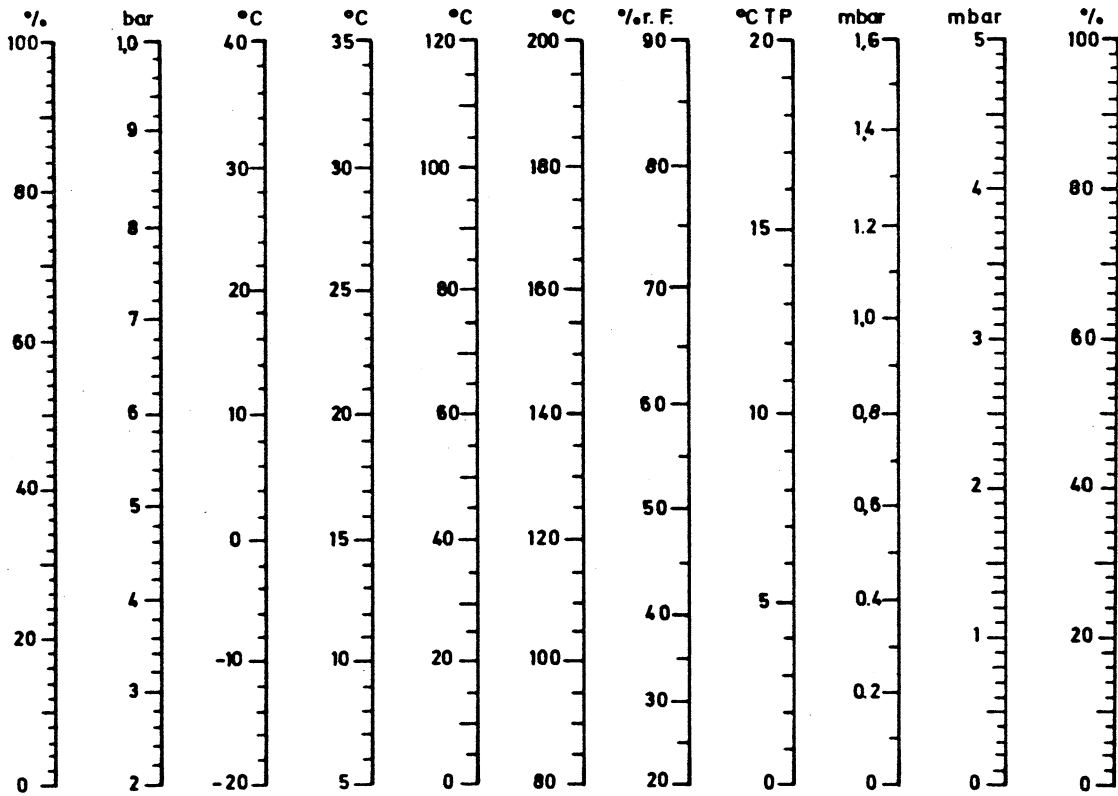

r.F. = h.r.
 r.h.
 u.r.